

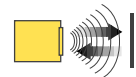

## Q45U Long Range Ultrasonic Sensors

*Piezoelectric Proximity Mode Sensors with Push button  
Programming of Sensing Window Limits*

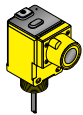

Ultrasonic

### Features

- Ultrasonic proximity detection from 0.25 to 3.0 meters (9.8 to 118 inches)
- Push button TEACH mode programming of sensing window limits
- Digital filtering for exceptional immunity to electrical and acoustic "noise"
- 12 to 24V dc operation; Bipolar outputs: one NPN (sinking) and one PNP (sourcing)
- ON/OFF presence detection or HIGH/LOW level control are switch-selectable
- Wide operating temperature range of -25° to +70°C; models available with temperature compensation
- Rugged design for use in demanding sensing environments; rated IEC IP67, NEMA 6P
- Choose models with integral 2 meter (6.5 foot) or 9 meter (30 foot) cable, or with mini-style or euro-style quick disconnect fitting
- External enable/disable feature for remote gating control

### Q45U Series Proximity Mode

Models	Temperature Compensation	Range	Cable	Supply Voltage	Output Type	Response Time
Q45UBB63BC Q45UBB63BCQ Q45UBB63BCQ6	Yes	250 mm - 3.0 m (9.8 - 118 in)	2 m (6.5 ft) 5-Pin Mini QD 5-Pin Euro QD	12-24V dc	Bipolar NPN/PNP	Programmable for 40, 80, 320, or 1280 milliseconds

#### Models with Temperature Compensation:

An increase in air temperature shifts both sensing window limits closer to the sensor. Conversely, a decrease in air temperature shifts both limits further away from the sensor. The shift is approximately 3.5% of the limit distance for a 20°C change in temperature.

Temperature compensated models maintain the position of both sensing window limits to within 1% of each limit distance over the range of from 0° to +50°C, and to within 2.5% over the full operating range of from -25° to +70°C.

#### For Q45U Ultrasonic Sensors:

- i) 9 m (30 ft) cables are available by adding suffix "W/30" to the model number of any cabled sensor (e.g. - Q45UBB63BC W/30)
- ii) A model with a QD connector requires an optional mating cable, see page 8.

# Q45U Long Range Ultrasonic Sensor

## Near and Far Sensing Limit Settings:

The Q45U features a single push button for programming of sensing window near and far limits (Figure 1). See the programming procedure on page 4.

## Status Indicators:

Status indicator LEDs are visible through the transparent, o-ring sealed Lexan® top cover. Indicator function in the RUN mode is, as follows:

- The green LED is on steadily whenever power is applied to the sensor, and flashes to indicate an overloaded output.
- The red LED lights when an echo is received, and flashes at a rate that is proportional to echo strength.
- The yellow LED lights whenever the outputs are conducting.

The 5-segment moving dot LED indicator displays the relative position of the target within the programmed sensing window. The #1 LED flashes when the target is closer than the near limit. The #5 LED flashes when the target is beyond the far limit.

## Output Response Settings:

**IMPORTANT:** Remove power before making any internal adjustments.

Using the two slots shown in Figure 1, a small flat-blade screwdriver may be used to lift up and remove the black inner cover to expose the 4-position DIP switch (Figure 2). Those switches are used to program the following functions:

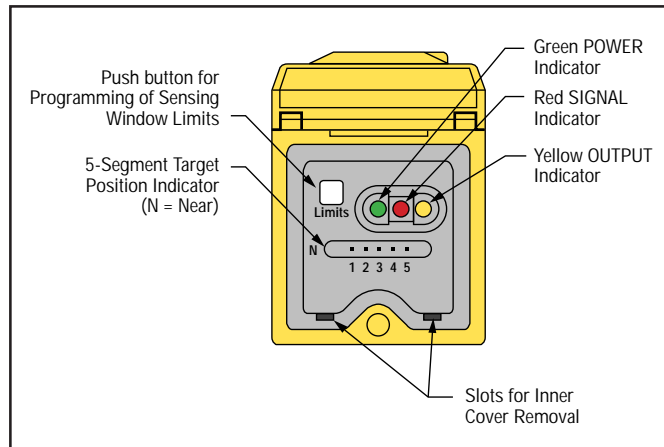

Figure 1. Q45U Features

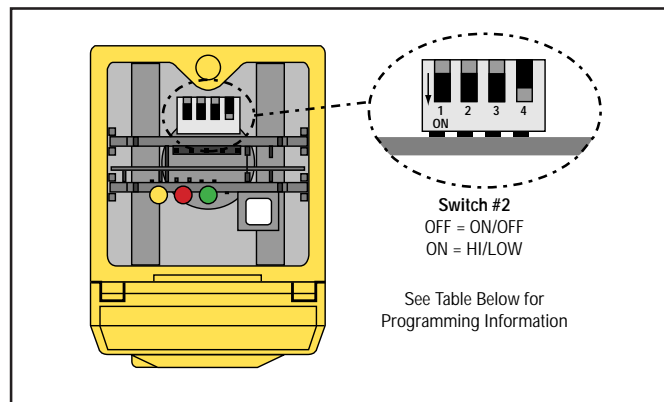

Figure 2. Q45U Programming Switches

Switch	Function		
1	<b>ON/OFF Mode</b> Output: On = normally closed (output energizes when target is absent) Off* = normally open (output energizes when target sensed)		<b>HIGH/LOW Mode</b> On = Pump Out Off = Pump In
2	Mode: On = <b>HIGH/LOW</b> (fill level control, see description, on page 3) Off* = <b>ON/OFF</b> (output follows sensing action)		
3 - 4	<b>Response (40 ms/cycle)</b>	<b>Switch 3</b>	<b>Switch 4</b>
	1 Cycle 2 Cycles 8 Cycles* 32 Cycles	Off On Off On	Off Off On On

\*Denotes factory settings.

**NOTE:** Response setting of 2 cycles, or higher, is recommended for optimum sonic and electrical noise immunity. Always use the slowest acceptable response speed for your application. Single cycle update is only recommended for short range (>1.0 m) applications looking for a stationary background target.

# Q45U Long Range Ultrasonic Sensor

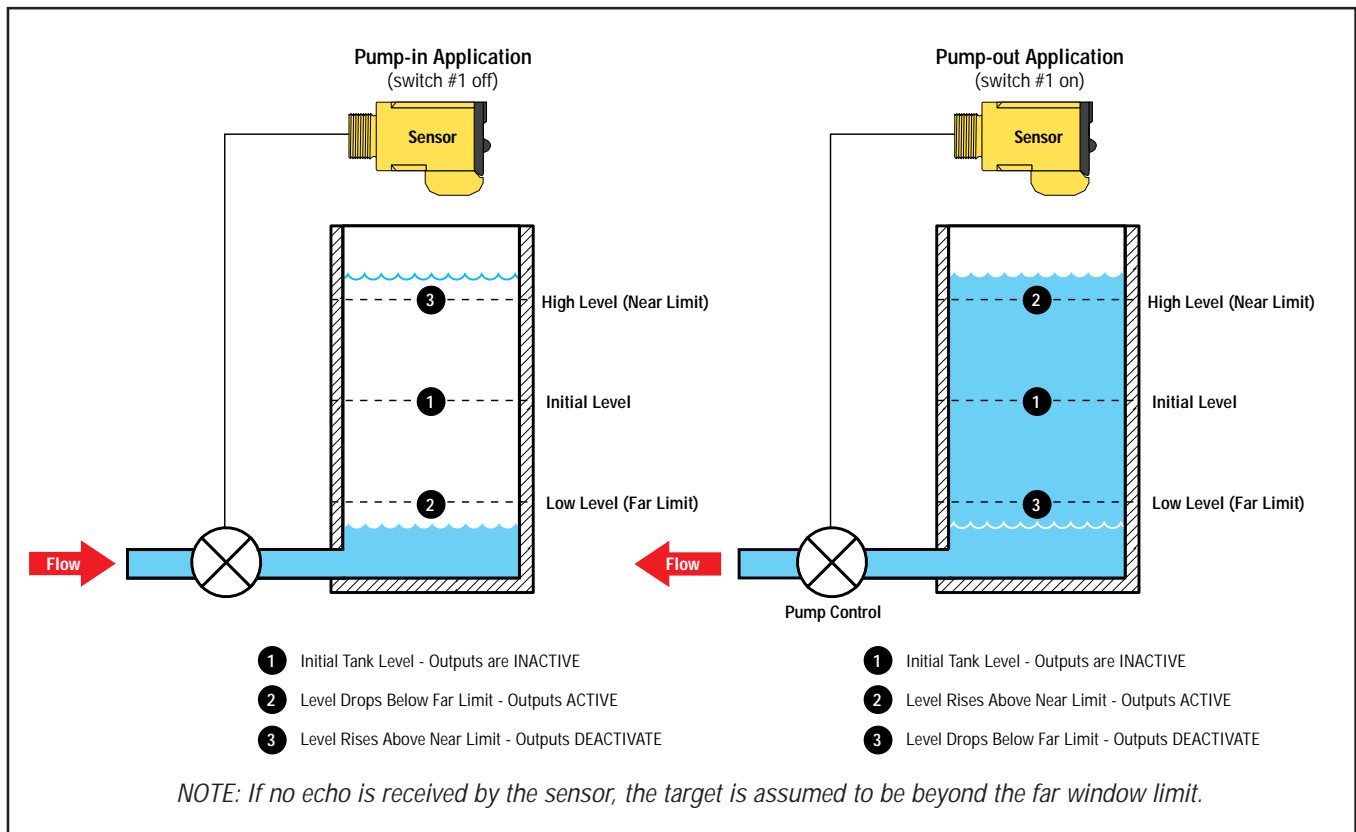



Figure 3. High/Low Level Control (switch #2 on)

The **HIGH/LOW** mode (switch #2 on) provides the switching logic required for fill-level, web tensioning control, and similar applications. In the HIGH/LOW mode, the output energizes when the target reaches the first sensing window limit, and stays energized until the target moves to the second limit. The output then de-energizes at the second limit and does not re-energize until the target moves, again, to the first limit. Figure 3 shows how pumping action might be controlled, directly, by the sensor in a fill-level application.

# Q45U Long Range Ultrasonic Sensor

## Window Limit Programming

The "Limits" push button, located under the transparent top cover, is used to program the near and the far limits. The near limit may be set as close as 250 millimeters (9.8 inches) and the far limit may be set as far as 3.0 meters (118 inches) from the transducer face. Minimum window width is 25 millimeters (1.0 inch). Whenever possible, use the actual target to be sensed when setting the window limits. The following procedure begins with the sensor in RUN mode.

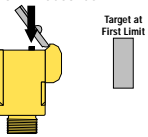
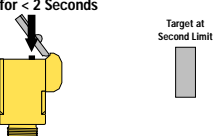
Push Button		Indicator Status
<b>Step 1</b> Push and hold until green indicator turns off (approximately 2 seconds)	Push and Hold for $\geq 2$ Seconds 	Green: Goes off Yellow: Is on steadily to indicate ready for teaching first limit Red: Flashes to indicate strength of echo or is off if no target is present
<b>Step 2</b> <b>FIRST LIMIT</b> (Near or Far) Place the target at the first limit and press the push button for less than 2 seconds	Push for $< 2$ Seconds 	Green: Remains off Yellow: Flashes at 2 Hz to indicate ready for teaching second limit Red: Comes on steadily for a moment, then resumes flashing to indicate strength of echo
<b>Step 3</b> <b>SET SECOND LIMIT</b> (Far or Near) Place the target at the second limit and press the push button for less than 2 seconds	Push for $< 2$ Seconds 	Green: Remains off, then comes on steadily (returns to <b>RUN</b> mode) Yellow: On steadily for a moment, then is either on or off to indicate output state (returns to <b>RUN</b> mode) Red: Comes on steadily for a moment, then resumes flashing to indicate strength of echo (returns to <b>RUN</b> mode)

### Notes regarding window limit programming:

- 1) Either the near or far limit may be programmed, first.
- 2) There is a 2 minute timeout for programming of the first limit. The sensor will return to RUN mode with the previously programmed limits. There is no timeout between programming of the first and second limit.
- 3) The programming sequence may be cancelled at any time by pressing and holding the push button for  $\geq 2$  seconds. The sensor returns to RUN mode with the previously programmed limits.
- 4) During limit programming, the 5-segment moving dot indicator displays the relative target position between 0 and 4.0 meters (the maximum recommended far limit position is 3.0 meters).
- 5) If the target is positioned between 3.0 and 4.0 meters, the 5th segment of the moving dot indicator flashes to indicate that a valid echo is received, but the target is beyond the recommended 3.0 meter maximum far limit.
- 6) If a limit is rejected during either programming step, the sensor will revert to the first limit programming step (Step 2 in programming chart). This will be indicated by Green - off, Red - flashing to indicate signal strength, and Yellow - on steadily.
- 7) If both limits are accepted, the sensor will return to RUN mode, which is indicated by the Green LED coming on steadily.
- 8) If the target is held at the same position for programming of both limits, the sensor will establish a 50-millimeter wide sensing window, centered on the target position.

# Q45U Long Range Ultrasonic Sensor

Q45U Series Product Specifications	
Proximity Mode Range	Near limit: 250 mm (9.8 in) min Far limit: 3.0 m (118 in) Note: The far limit may be extended as far as 3.9 m for good acoustical targets (hard surfaces with area > 100 cm <sup>2</sup> )
Supply Voltage and Current	12 to 24V dc (10% maximum ripple) at 100mA, exclusive of load
Supply Protection Circuitry	Protected against reverse polarity and transient voltages
Output Configuration	Bipolar: one current sourcing (PNP) and one current sinking (NPN) open-collector transistor; The following may be selected by a 4-position DIP switch located on top of the sensor, beneath a transparent o-ring sealed LEXAN® cover (see page 2): Switch 1: Output normally open/normally closed (pump in/pump out) Switch 2: High/Low level control mode or on/off presence sensing mode Switch 3 & 4: Response speed selection (digital filter)
Output Rating	150mA maximum (each) <b>Off-state leakage current</b> <25 microamp at 24V dc <b>On-state saturation voltage</b> <1.5V at 10mA; <2.0V at 150mA
Output Protection Circuitry	Protected against false pulse on power-up and continuous overload or short-circuit of outputs
Performance Specifications	Repeatability: ±0.1% of measured distance (±.50 mm min) Minimum Window Width: 25 mm (1.0 in) Hysteresis: 10 mm (0.4 in)
Indicators	Three status LEDs: GREEN <b>glowing steadily</b> = power to sensor is "on" GREEN <b>flashing</b> = output is overloaded YELLOW <b>glowing steadily</b> = outputs are conducting (Yellow LED also indicates programming status during setup mode) RED <b>flashing</b> = indicates relative strength of received echo 5-segment moving dot LED indicates the position of the target within the sensing window
Construction	Molded VALOX® thermoplastic polyester housing, o-ring sealed transparent LEXAN® top cover, and stainless steel hardware. Q45U sensors are designed to withstand 1200 psi washdown. The base of cabled models has a 1/2"-14NPS internal conduit thread
Environmental Rating	Leakproof design is rated IEC IP67; NEMA 6P
Connections	2 m (6.5 ft) or 9 m (30 ft) attached cable, or 5-pin mini-style or 5-pin euro-style quick disconnect fitting
Operating Temperature	<b>Temperature:</b> -25 to +70°C (-13 to +158°F) <b>Maximum relative humidity:</b> 100%
Vibration and Mechanical Shock	All models meet Mil. Std. 202F requirements. Method 201A (Vibration: 10 to 60Hz max., double amplitude 0.06-inch, maximum acceleration 10G). Method 213B conditions H & I (Shock: 75G with unit operating; 100G for non-operation) Also meets IEC 947-5-2 requirements: 30G, 11 ms duration, half sine wave
Hysteresis	<b>ON/OFF mode:</b> 10 mm <b>HIGH/LOW mode:</b> 0 mm
Application Notes	<b>Minimum target size:</b> 50 mm x 50 mm aluminum plate at 3.0 m (118 in) <b>Enable/Disable:</b> Connect yellow wire to +5 to 24V dc to enable sensor and 0 to +2V dc to disable sensor. When the sensor is disabled, the last output state is held until the sensor is re-enabled. The wire must be held to the appropriate voltage for at least 20 ms for the sensor to enable or disable.

VALOX® and LEXAN® are registered trademarks of General Electric Company

# Q45U Long Range Ultrasonic Sensor

## Q45U Response Curves

Q45U Effective Beam with 2.5 cm Rod Target (Typical)

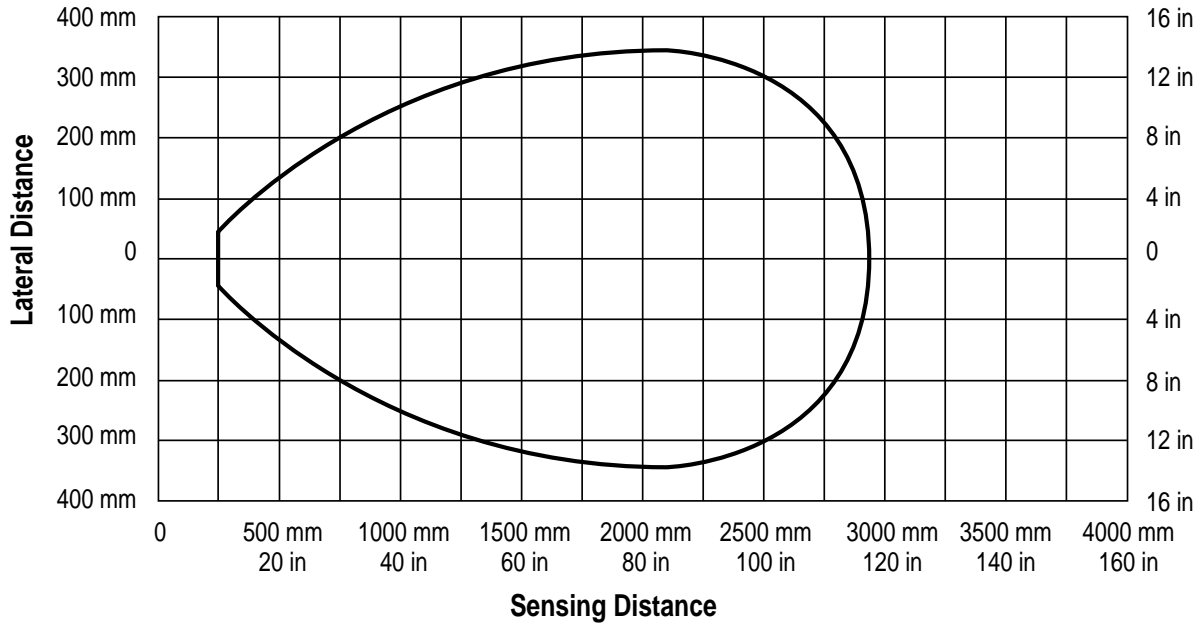

Q45U Effective Beam with 100 mm x 100 mm Plate Target (Typical)

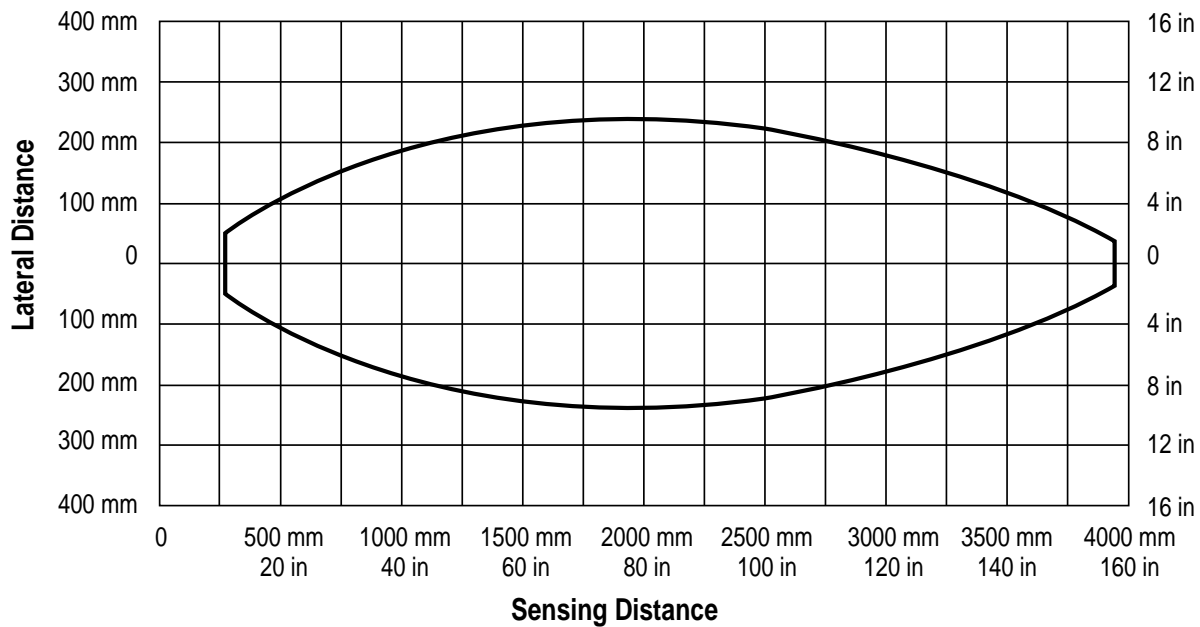

# Q45U Long Range Ultrasonic Sensor

## Q45U Series Hookup Diagrams

Q45U Sensor with Attached Cable

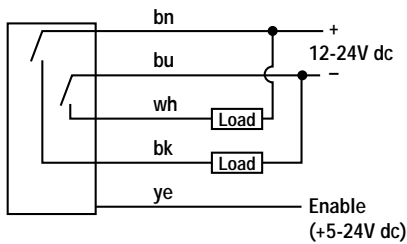

Q45U Sensor with Quick Disconnect  
(5-Pin Mini-Style)  
("Q" model suffix)

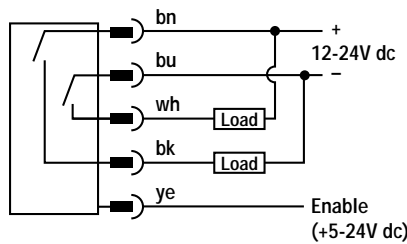

Q45U Sensor with Quick Disconnect  
(5-Pin Euro-Style)  
("Q6" model suffix)

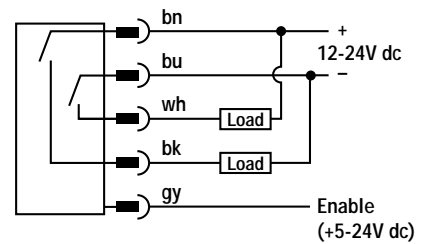

### Quick Disconnect (QD) Option

Q45U Ultrasonic sensors are sold with either a 2 m (6.5 ft) or a 9 m (30 ft) attached cable, or with a 5-pin mini-style or 5-pin euro-style QD cable fitting.

For information on QD cables, see next page.

### 5-Pin Mini-Style Pin-out (Cable Connector Shown)

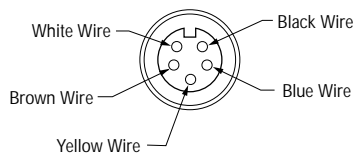

### 5-Pin Euro-Style Pin-out (Cable Connector Shown)

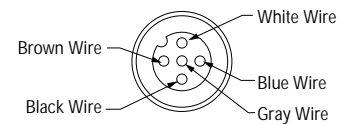

## Analog Q45U Series Dimension Information

Analog Q45U Sensor with Cable Attached

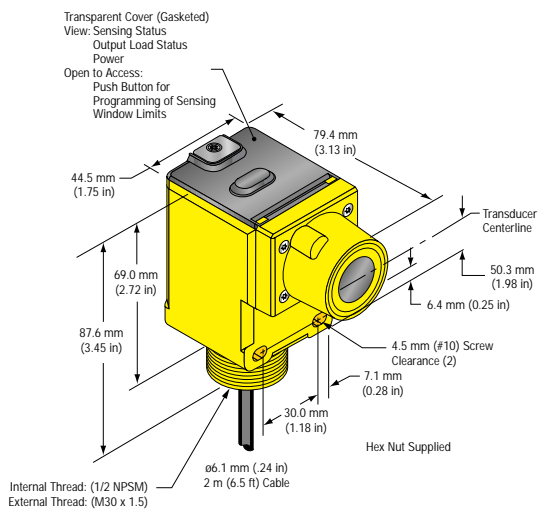

Analog Q45U Sensor with 5-Pin Mini-Style QD

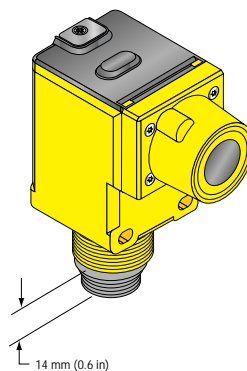

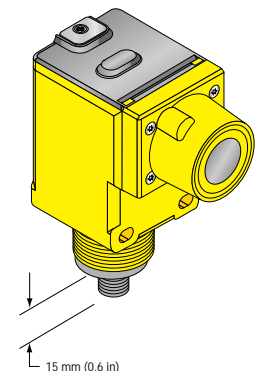

Analog Q45U Sensor with 5-Pin Euro-Style QD

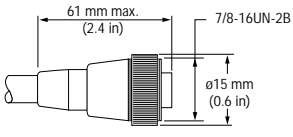

# Q45U Long Range Ultrasonic Sensor

## QUICK DISCONNECT (QD) CABLES

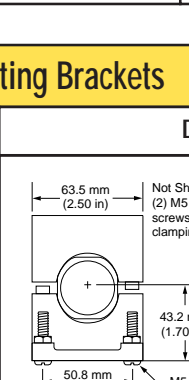
Style	Model	Length	Connector
5-Pin Mini	MBCC-506 MBCC-512 MBCC-530	2 meters (6.5 ft) 4 meters (12 ft) 9 meters (30 ft)	
5-Pin Euro Straight	MQDC1-506 MQDC1-515 MQDC1-530	2 meters (6.5 ft) 5 meters (15 ft) 10 meters (30 ft)	
5-Pin Euro Right -angle	MQDC1-506RA MQDC1-515RA MQDC1-530RA	2 meters (6.5 ft) 4 meters (12 ft) 9 meters (30 ft)	

**WARRANTY:** Banner Engineering Corporation warrants its products to be free from defects for one year. Banner Engineering Corporation will repair or replace, free of charge, any product of its manufacture found to be defective at the time it is returned to the factory during the warranty period. This warranty does not cover damage or liability for the improper application of Banner products. This warranty is in lieu of any other warranty either expressed or implied.



**WARNING** These ultrasonic presence sensors do NOT include the self-checking redundant circuitry

necessary to allow their use in personnel safety applications. A sensor failure or malfunction can result in either an energized or a de-energized sensor output condition.

Never use these products as sensing devices for personnel protection. Their use as a safety device may create an unsafe condition which could lead to serious injury or death.

Only MICRO-SCREEN™ MINI-SCREEN®, MULTI-SCREEN®, MACHINE-GUARD™ and PERIMETER-GUARD™ Systems, and other systems so designated, are designed to meet OSHA and ANSI machine safety standards for point-of-operation guarding devices. No other Banner sensors or controls are designed to meet these standards, and they must NOT be used as sensing devices for personnel protection.

## Mounting Brackets

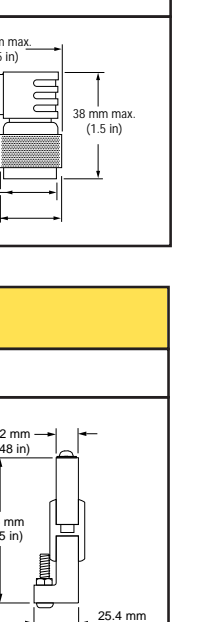
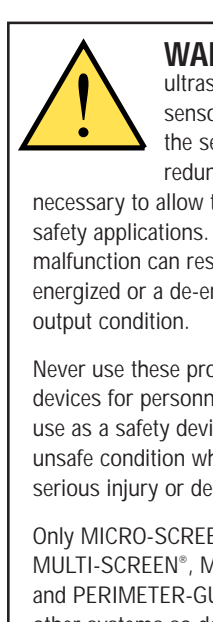
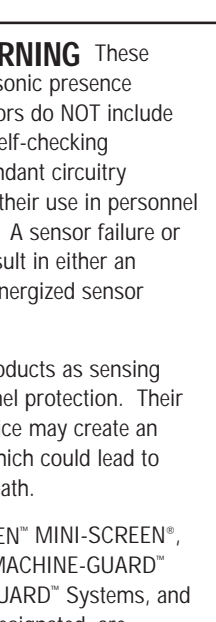
Model	Description	Dimensions
SMB30S	<ul style="list-style-type: none"> <li>30 mm swivel, black VALOX® bracket</li> <li>Stainless steel mounting hardware included</li> </ul>	
SMB30C	<ul style="list-style-type: none"> <li>30 mm split clamp, black VALOX® bracket</li> <li>Stainless steel mounting hardware included</li> </ul>	
SMB30MM	<ul style="list-style-type: none"> <li>30 mm, 11-gauge, stainless steel bracket with curved mounting slots for versatility and orientation</li> <li>Clearance for M6 (1/4 in) hardware</li> </ul>	

**BANNER**<sup>®</sup>  
the photoelectric specialist